



# SYSTEMS

Finestre e portefinestre a battente  
Casement windows





# Indice

## Index

Il nostro ecosistema	<i>Our ecosystem</i>	p. 03
8 buone ragioni	<i>8 good reasons</i>	p. 04
Ecosostenibilità	<i>Eco-sustainability</i>	p. 08
Finestre e portefinestre a battente	<i>Casement windows</i>	
• Le nostre linee	• <i>Our product lines</i>	p. 12
• Forme estetiche	• <i>Aesthetic shapes</i>	p. 15
• Gli accessori	• <i>The accessories</i>	p. 16
• Tipologie di aperture	• <i>Opening typologies</i>	p. 18
Le linee	<i>The product lines</i>	
• Linea Minimale	• <i>Minimal line</i>	p. 21
• Linea Origini	• <i>Origins line</i>	p. 27
• Linea Alluminio-legno	• <i>Aluminium-wood line</i>	p. 33
Tecnologia	<i>Technology</i>	p. 38
Posa Clima	<i>Posa Clima</i>	p. 40
Prestazioni	<i>Performances</i>	p. 42



# Il nostro ecosistema

## Our ecosystem

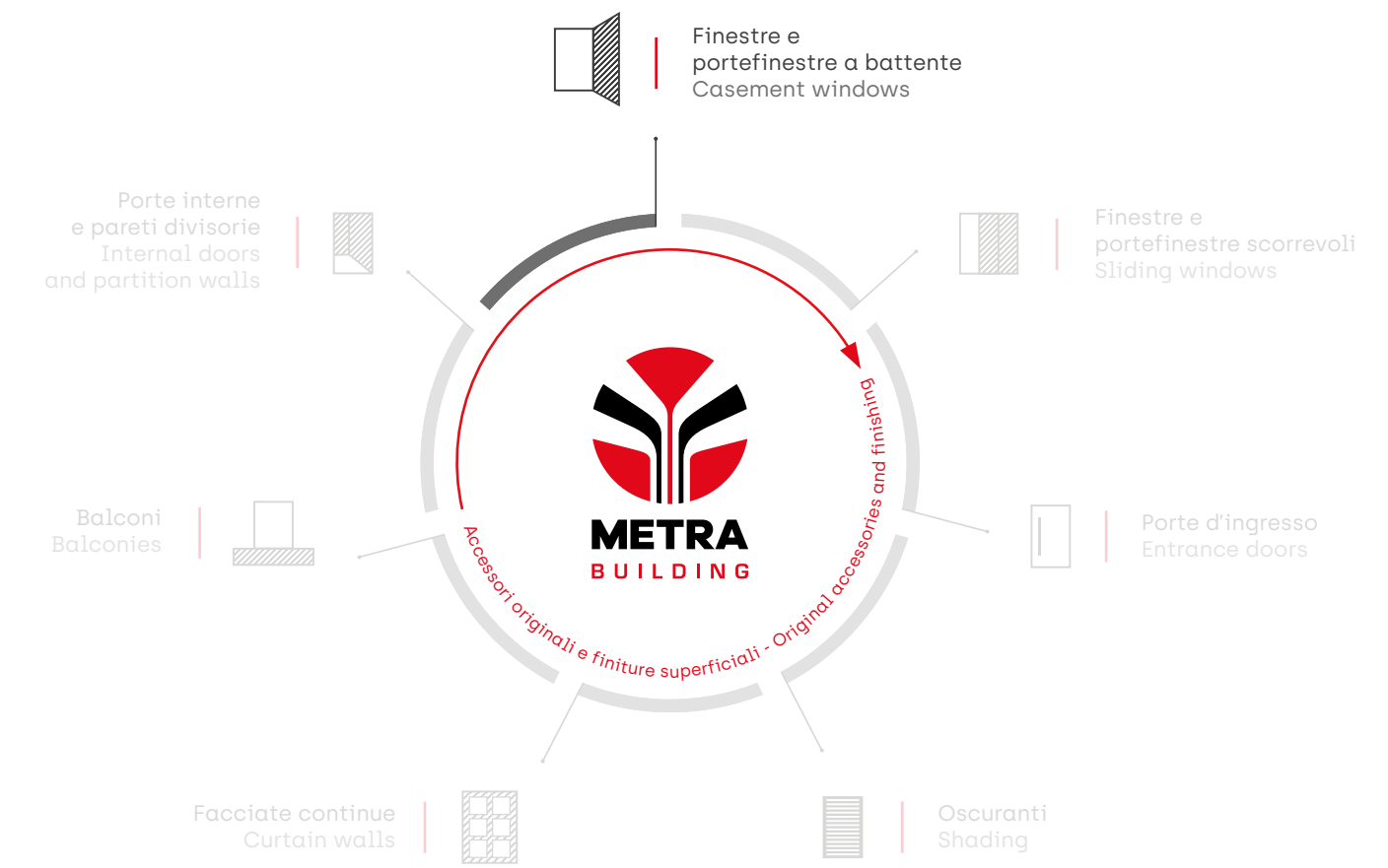

Qualità certificata  
Certified quality





## Serramenti in alluminio METRA Building: 8 buone ragioni

### METRA Building Aluminium windows and doors: 8 good reasons

#### Essenziale e luminoso Essential and bright



Geometrie compatte che consentono di recuperare luminosità negli spazi. La tecnologia giunge ai suoi massimi livelli e si condensa fino a soli 63 mm di spessore. La bellezza si traduce in design e si completa con accessori a scomparsa e maniglie minimali.

*Compact geometries that allow to recover brightness in spaces. The technology reaches its maximum level and condenses to a thickness of only 63 mm. Beauty translates into design and is completed with concealed accessories and minimalist handles.*

#### Praticamente eterni Practically eternal



Resistenza meccanica, stabilità, robustezza e manutenzione ridotta ai minimi termini. Numerose qualità e straordinari vantaggi in un unico materiale in grado di durare per sempre.

*Mechanical resistance, stability, robustness and maintenance reduced at the minimum. Numerous qualities and extraordinary advantages in a single material able to last forever.*

#### Isolamento termico e acustico da classe Gold Gold class thermal and acoustic insulation



Con la tecnologia HES (High Energy Saving) l'isolamento termico è ai massimi livelli prestazionali. La riduzione dei costi energetici nel riscaldamento e raffreddamento è assicurata, così come il comfort abitativo reso ancor più elevato dal perfetto isolamento acustico.

*With HES (High Energy Saving) technology thermal insulation is at the highest performance levels. The reduction of energy costs in heating and cooling is ensured, as well as the living comfort made even higher by perfect sound insulation.*

#### Sonni tranquilli Sleep soundly



Sicurezza garantita con i sistemi antieffrazione in classe RC2 e RC3. un sistema di chiusura perimetrale fino a 16 punti (predisposizione antifurto) capace di resistere a scassinatori e malintenzionati.

*Guaranteed security with class RC2 and RC3 burglar-proof systems. a perimeter locking system with up to 16 points (anti-theft predisposition) able to resist burglars and malicious intruders.*



## Tutti i colori della performance

All colours of performance



Spazio alla fantasia nella scelta dei colori. Finiture ossidate, verniciature opache, lucide, extralucide e trattamenti effetto legno a marchio Qualanod-Qualicoat-Seaside-Qualideco anche con opzione antibatterica. Durata assicurata fino a 30 anni.

*Space for imagination in the choice of colours. Oxidised finishes, matt, gloss, high-gloss and wood-effect treatments under the Qualanod-Qualicoat-Seaside-Qualideco brand also with antibacterial option. Guaranteed durability up to 30 years.*

## Più spazio al movimento

More space for movement



Estetica e accessibilità in un unico sistema che abbatte le barriere architettoniche e consente facili accessi. Con la soglia ribassata gli ostacoli si riducono al minimo.

*Aesthetics and accessibility in a single system that breaks down architectural barriers and allows easy access. With the lowered threshold, obstacles are reduced to a minimum.*

## Sistema integrato perfetto

Perfect integrated system

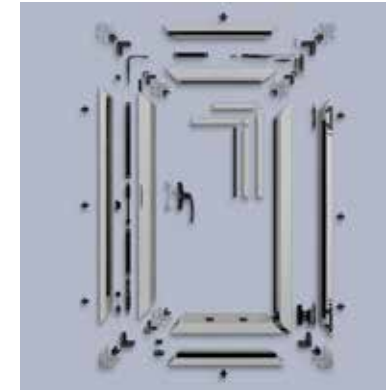

Maniglie, meccanismi di apertura e chiusura, cerniere, guarnizioni e squadrette: tutti gli accessori coordinati, rigorosamente originali METRA Building, si fondono con il serramento per garantire i migliori risultati.

*Handles, opening and closing devices, hinges, gaskets and corner cleats: all matching accessories, rigorously METRA Building original, blend with the window or door to guarantee the best results.*

## Eccellenza italiana

Italian excellence



Tutti i serramenti METRA Building sono estrusi in Italia e rispondono alle più selettive certificazioni internazionali. I migliori processi produttivi integrati, uniti a oltre 60 anni di know-how, per creare un prodotto bello, sicuro e dalle prestazioni inimitabili.

*All METRA Building windows and doors are extruded in Italy and meet the most selective international certifications. The best integrated production processes, combined with over 60 years of know-how, to create a beautiful and safe product with inimitable performance.*

I nostri profili in alluminio sono presenti in alcune delle più prestigiose realizzazioni al mondo: dalla iconica Piramide del Louvre, alle torri di New York fino agli avveniristici grattacieli di Dubai.

*Our aluminium profiles are featured in some of the most prestigious projects in the world: from the iconic Louvre Pyramid to the towers of New York and the futuristic skyscrapers of Dubai.*



Finestre e portefinestre a battente  
Casement windows

## Ecosostenibilità Eco-sustainability

L'alluminio è una scelta sostenibile per gli edifici: ha un'elevata durabilità, ridotta manutenzione e può essere riciclato al 100% e all'infinito, senza perdere le sue proprietà.

L'attenzione per la riduzione dell'impatto ambientale di Metra riguarda tutta la catena del valore dell'alluminio, grazie all'elevato contenuto di materiale riciclato nei profili e l'assenza di VOC, che si concretizza nelle certificazioni ambientali (EPD) ottenute sui prodotti.

Metra Building mette a disposizione un portafoglio di soluzioni per garantire una progettazione sostenibile a basso impatto ambientale, che garantiscono efficienza energetica e favoriscono l'utilizzo della luce naturale, in linea con i requisiti dei protocolli LEED, BREEAM, DGNB e il rispetto dei Criteri Ambientali Minimi.

*Aluminium is a sustainable choice for buildings: it has high durability, low maintenance and can be recycled 100% and infinitely without losing its properties.*

*The attention to reducing Metra's environmental impact concerns the entire aluminium value chain, thanks to the high content of recycled material in the profiles and the absence of VOCs, which is reflected in the environmental certifications (EPD) obtained on the products.*

*Metra Building offers a portfolio of solutions to guarantee sustainable design with low environmental impact, which guarantee energy efficiency and support the use of natural light, in line with the requirements of LEED, BREEAM, DGNB protocols and compliance with Minimum Environmental Criteria.*

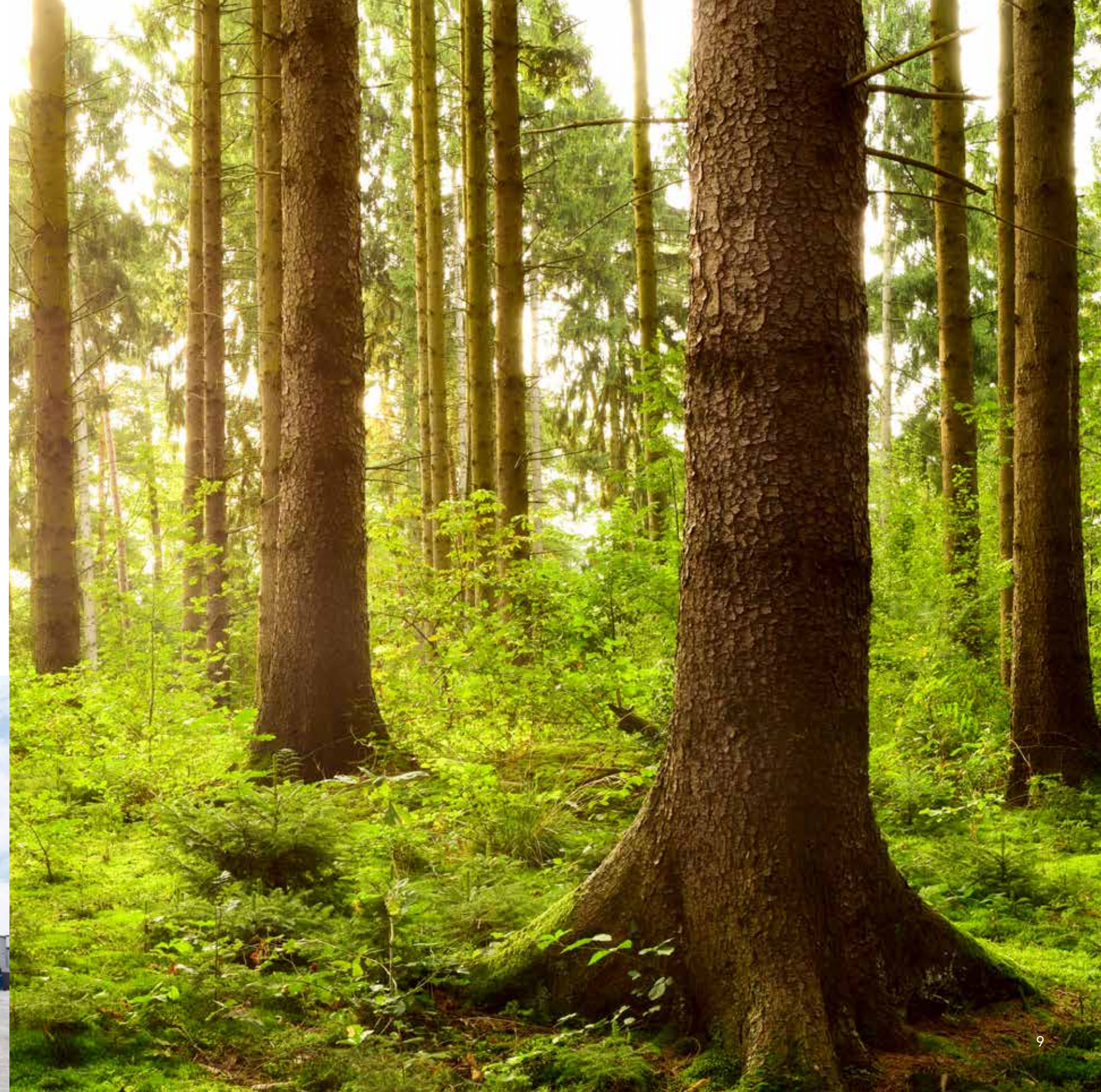



# Finestre e portefinestre a battente

Casement windows





Finestre e portefinestre a battente  
Casement windows

## Le nostre linee Our product lines



Linea Minimale  
Minimal line



Linea Origini  
Origins line



Linea Alluminio-legno  
Aluminium-wood line



Linea Minimale  
Minimal line

Linea Origini  
Origins line

Linea Alluminio-legno  
Aluminium-wood line





## Forme estetiche Aesthetic shapes

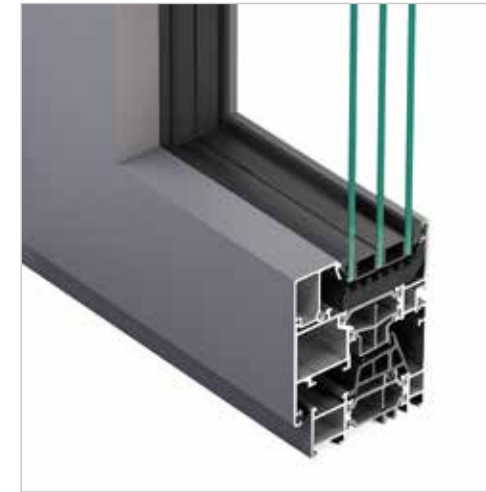

**Piana / Basic**



**Sagomata / Shaped**

Disponibile solo/Only Available:  
**Linea Origini/Origins line**  
**Linea Alluminio-legno/Aluminium-wood line**



**Ferro / Iron**

Disponibile solo/Only Available:  
**Linea Minimale/Minimal line**  
**Linea Origini/Origins line**



**Scomparsa / Hidden**

Disponibile solo/Only Available:  
**Linea Minimale/Minimal line**  
**Linea Origini/Origins line**



## Gli accessori originali METRA Building

### The METRA Building original accessories

- a** **Cerniera a scomparsa**  
**Concealed hinge**
- La perfetta soluzione che unisce estetica essenziale, robustezza e tecnologie all'avanguardia.
- The perfect solution that combines essential aesthetics, stability and cutting-edge technology.*
- 
- b** **Soglia ribassata**  
**Low sill**
- Più spazio al movimento, nel rispetto del design.
- More space for movement, while respecting design.*
- 
- c** **Maniglia minimale**  
**Minimal handle**
- Un elemento originale firmato METRA Building dal minimo impatto visivo.
- An original element signed METRA Building with minimal visual impact.*
- 
- d** **Guarnizioni**  
**Gaskets**
- Le guarnizioni in materiale EPDM garantiscono estrema tenuta e durabilità. Il loro design le rende discrete dando spazio alla luce.
- The EPDM gaskets ensure extreme tightness and durability. Their design makes them discreet giving space to light.*
- 
- e** **Domotica**  
**Home automation**
- Soluzioni motorizzate per un ambiente smart, con semplicità.
- Motorised solutions that simplify life and make it smart, with ease.*





Finestre e portefinestre a battente  
Casement windows

# Tipologie di aperture

## Opening typologies

Finestre e portefinestre  
Windows and doors

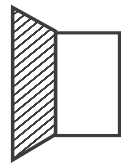

1 anta  
1 side hung casement

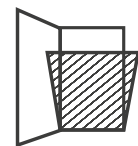

Anta-ribalta  
Tilt-and-turn

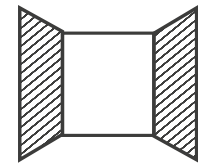

2 ante  
2 side hung casements

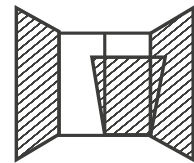

2 ante con anta-ribalta  
2 side hung casements with  
tilt-and-turn



Vasistas  
Bottom hung casement

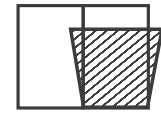

Vasistas scorrevole parallelo  
Tilting-sliding

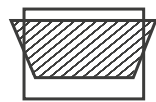

Bilico orizzontale e verticale  
Horizontal and vertical  
pivot window

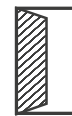

1 anta apertura esterna  
1 leaf outward opening



2 ante apertura esterna  
2 leaf outward opening





Finestre e portefinestre a battente  
Casement windows

Linea Minimale  
Minimal line

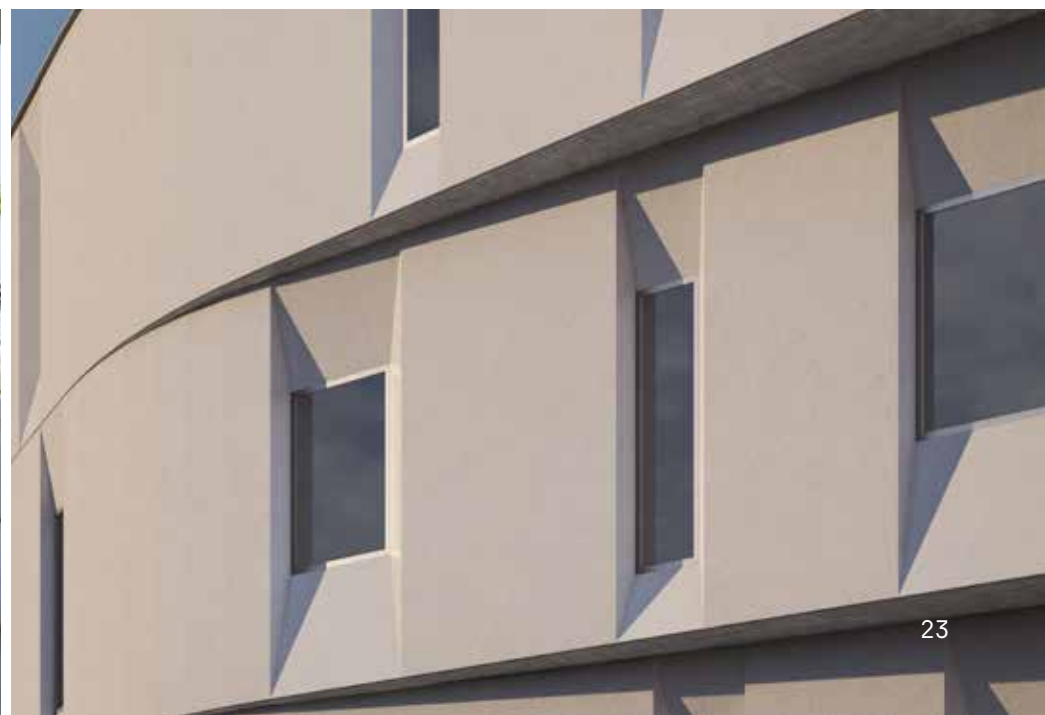
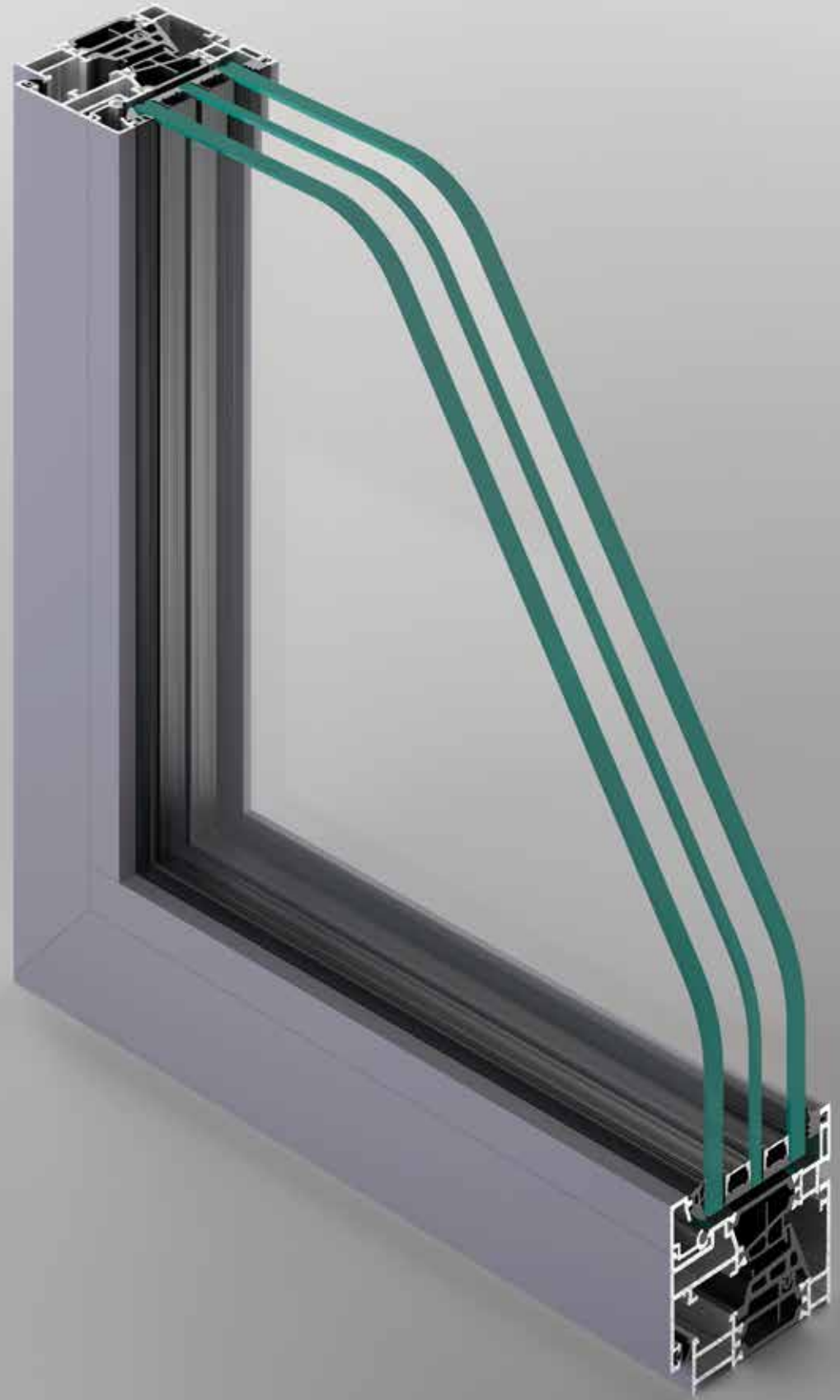



Finestre e portefinestre a battente  
Casement windows

Linea Minimale  
Minimal line

# Linea Minimale

## Minimal line

Luce e trasparenza: le linee guida del design moderno assumono caratteristiche sempre più orientate a rendere fluide le divisioni ambientali tra interno ed esterno. I sistemi integrati della Linea Minimale METRA Building garantiscono il massimo della luminosità con eccellenti performance di isolamento termico e acustico. Spessori ridotti al minimo e un'importante recupero di luce filtrante, con prodotti super performanti che arrivano a condensarsi in soli 63 mm.

*Light and transparency: the guidelines of modern design assume features increasingly oriented towards fluid divisions between indoor and outdoor environments. The integrated systems of the METRA Building Minimal Line guarantee a maximum of luminosity with excellent thermal and acoustic insulation. Minimal thicknesses and important recovery of filtering light, with high-performance products condensing in only 63 mm.*

### NC 75 STH HES LUX

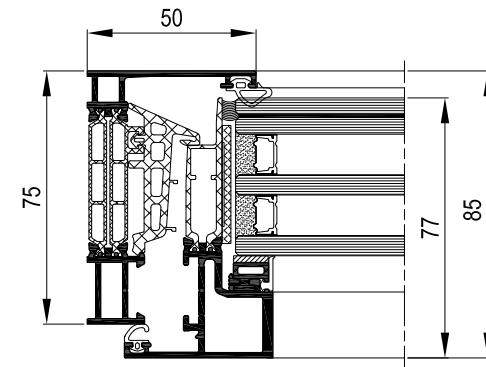

Telaio fisso Frame	Telaio mobile Sash	Spessore vetri Glass thickness
75 mm	77 mm	da 28 mm a 50 mm from 28 mm to 50 mm

Trasmittanza termica  
Thermal transmittance

Valore Uf 1,3-2,5 W/m<sup>2</sup> K  
Uf value 1,3-2,5 W/m<sup>2</sup> K

### NC 75 STH HES SLIM

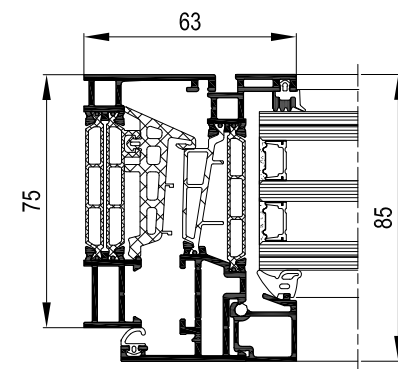

Telaio fisso Frame	Telaio mobile Sash	Spessore vetri Glass thickness
75 mm	85 mm	da 27 mm a 66 mm variabile in funzione della linea estetica depending on the aesthetic line

Trasmittanza termica  
Thermal transmittance

Valore Uf 1,2-2,4 W/m<sup>2</sup> K  
Uf value 1,2-2,4 W/m<sup>2</sup> K

### NC 65 STH HES SLIM

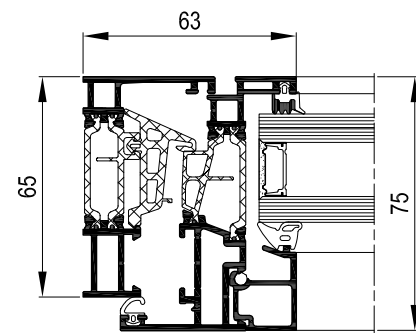

Telaio fisso Frame	Telaio mobile Sash	Spessore vetri Glass thickness
65 mm	75 mm	da 17 mm a 56 mm variabile in funzione della linea estetica from 17 mm to 56 mm depending on the aesthetic line

Trasmittanza termica  
Thermal transmittance

Valore Uf 1,7-2,4 W/m<sup>2</sup> K  
Uf value 1,7-2,4 W/m<sup>2</sup> K





Finestre e portefinestre a battente  
Casement windows

Linea Origini  
Origins line







# Sistema HES

## HES system

La più performante tra le linee METRA Building, caratterizzata dal sistema HES, High Energy Saving, ideale per chi ricerca un design essenziale, studiato per ottenere il massimo della luminosità e trasparenza con eccellenti performance di isolamento termico e acustico.

Focus su NC 90 STH HES, la prima finestra interamente in alluminio ad ottenere la prestigiosa certificazione "Finestra Qualità CasaClima" in classe Gold. Tale marchio, rilasciato dall'Agenzia CasaClima, ente terzo super partes, garantisce la qualità energetica dell'infisso e la posa in opera di controtelaio e telaio effettuata a regola d'arte.

*The most efficient of the METRA Building lines, characterized by the HES system, High Energy Saving, ideal for those looking for an essential design achieving maximum brightness and transparency with excellent thermal and acoustic insulation performance.*

*Focus on NC 90 STH HES, the first window entirely in aluminium to obtain the prestigious certification "ClimateHouse Quality Window" in Gold class. This label, issued by the Agenzia CasaClima, an impartial third-party agency, guarantees the energy quality of the window and the installation of counterframe and frame made in a workmanlike manner.*

### NC 90 STH HES

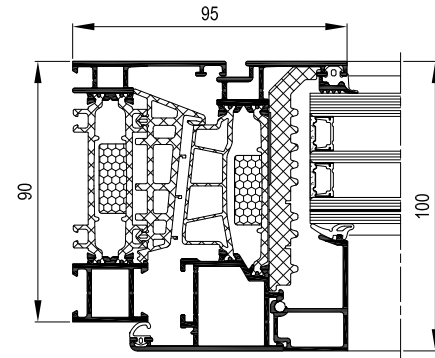

Telaio fisso Frame	Telaio mobile Sash	Spessore vetri Glass thickness
90 mm	100 mm	da 12 mm a 83 mm variabile in funzione della linea estetica from 12 mm to 83 mm depending on the aesthetic line

Trasmittanza termica  
Thermal transmittance

Valore Uf 0,84-1,8 W/m<sup>2</sup> K  
Uf value 0,84-1,8 W/m<sup>2</sup> K

### NC 65 STH HES

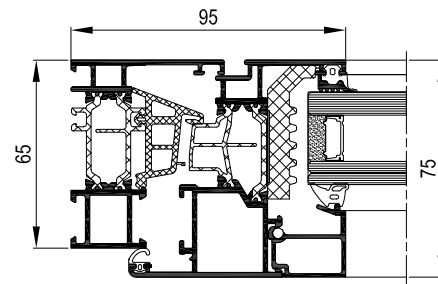

Telaio fisso Frame	Telaio mobile Sash	Spessore vetri Glass thickness
65 mm	75 mm	da 8 mm a 60 mm variabile in funzione della linea estetica from 8 mm to 60 mm depending on the aesthetic line

Trasmittanza termica  
Thermal transmittance

Valore Uf 1,2-2,3 W/m<sup>2</sup> K  
Uf value 1,2-2,3 W/m<sup>2</sup> K

### NC 75 STH HES

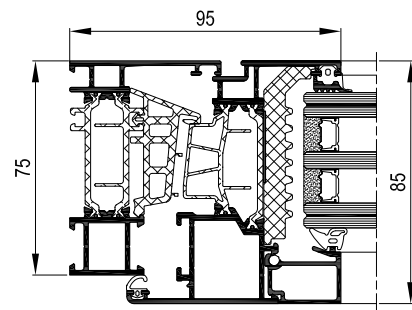

Telaio fisso Frame	Telaio mobile Sash	Spessore vetri Glass thickness
75 mm	85 mm	da 8 mm a 70 mm variabile in funzione della linea estetica from 8 mm to 70 mm depending on the aesthetic line

Trasmittanza termica  
Thermal transmittance

Valore Uf 1,0-2,1 W/m<sup>2</sup> K  
Uf value 1,0-2,1 W/m<sup>2</sup> K

## Altre soluzioni Other solutions

### NC 50 I

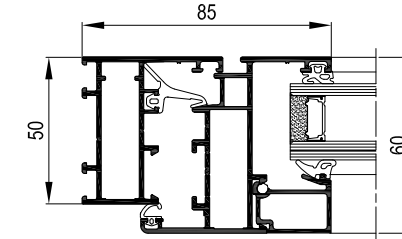

Telaio fisso Frame	Telaio mobile Sash	Spessore vetri Glass thickness
50 mm	60 mm	da 4 mm a 42 mm variabile in funzione della linea estetica from 4 mm to 42 mm depending on the aesthetic line

### NC 50 STH

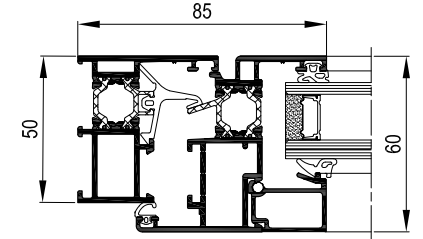

Telaio fisso Frame	Telaio mobile Sash	Spessore vetri Glass thickness
50 mm	60 mm	da 4 mm a 42 mm variabile in funzione della linea estetica from 4 mm to 42 mm depending on the aesthetic line

Trasmittanza termica  
Thermal transmittance

Valore Uf 2,7-3,8 W/m<sup>2</sup> K  
Uf value 2,7-3,8 W/m<sup>2</sup> K



© Simone Bossi Photographer



© Simone Bossi Photographer



Finestre e portefinestre a battente  
Casement windows

Linea Alluminio-legno  
Aluminium-wood line





Finestre e portefinestre a battente  
Casement windows

Linea Alluminio-legno  
Aluminium-wood line

## Linea Alluminio-legno Aluminium-wood line

Il calore del legno e la solidità e durabilità dell'alluminio si uniscono nella linea Alluminio-Legno di METRA Building. Sistemi integrati con il lato esterno in alluminio disponibile in illimitate finiture e il lato interno rivestito da uno spesso strato di legno naturale, da scegliere tra varie essenze. Le prestazioni di questa linea sono straordinarie: perfetta tenuta, resistenza, indeformabilità, isolamento acustico, tenuta all'acqua, resistenza all'aria, alla salsedine e agli agenti atmosferici aggressivi e manutenzione pari a zero. Inoltre, il taglio termico garantisce il massimo risparmio energetico. Alle performance si sommano anche gli alti livelli di sicurezza antieffrazione, meccaniche di apertura e chiusura perfette, predisposizione antifurto, predisposizione all'automazione domotica.

*The warmth of wood and the solidity and durability of aluminium merge in the METRA Building Aluminium-Wood line.*

*Integrated systems with an external aluminium side available in unlimited finishes and the inside coated with a thick layer of natural wood, to be chosen among a variety of wood types. The performances of this line are extraordinary: perfect tightness, resistance, non-deformability, sound insulation, water tightness, resistance to air, salt and aggressive atmospheric agents and zero maintenance. In addition, the thermal break guarantees the maximum energy saving. In addition, high levels of burglar-proof security, mechanical safety with perfect opening and closing, predisposition for burglar alarm systems and home automation.*

### AELLE 100 STH

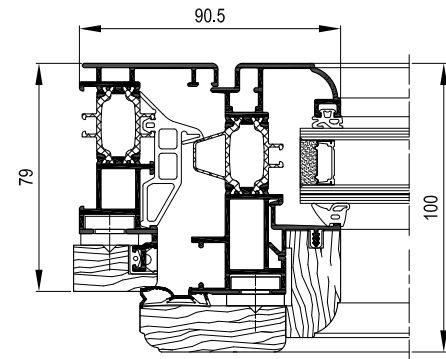

Telaio fisso Frame	Telaio mobile Sash	Spessore vetri Glass thickness
79 o 89 mm variabile in funzione della linea estetica 79 or 89 mm depending on the aesthetic line	100 mm	da 26 mm a 59 mm variabile in funzione della linea estetica from 26 mm to 59 mm depending on the aesthetic line
Trasmittanza termica Thermal transmittance	Valore Uf 1,6-2,4 W/m <sup>2</sup> K Uf value 1,6-2,4 W/m <sup>2</sup> K	





## Tecnologia Technology

- 1 Telaio fisso
- 2 Telaio mobile
- 3 Fermavetro disponibile in varie misure in base allo spessore del vetro
- 4 Vetro isolante ad 1 intercapedine (doppio vetro) o 2 intercapedini (triplo vetro)
- 5 Guarnizioni cingivetro senza effetto cornice
- 6 Astine termiche in poliammide low lambda con innesti isolanti atti a ridurre la dispersione per convezione
- 7 Guarnizione centrale di tenuta in EPDM espanso
- 8 Guarnizione di battuta interna in EPDM
- 9 Guarnizione sottovetro isolante

- 1 Frame
- 2 Sash
- 3 Glazing bead available in various sizes based on the glass thickness
- 4 Insulating glazing with 1 air space (double glazing) or 2 air spaces (triple glazing)
- 5 Glazing gaskets without frame effect
- 6 Low lambda polyamide bars with insulating plugs to reduce convection loss
- 7 Central sealing gasket in EPDM foam
- 8 EPDM internal rabbet gasket
- 9 Special under glass insulating gasket

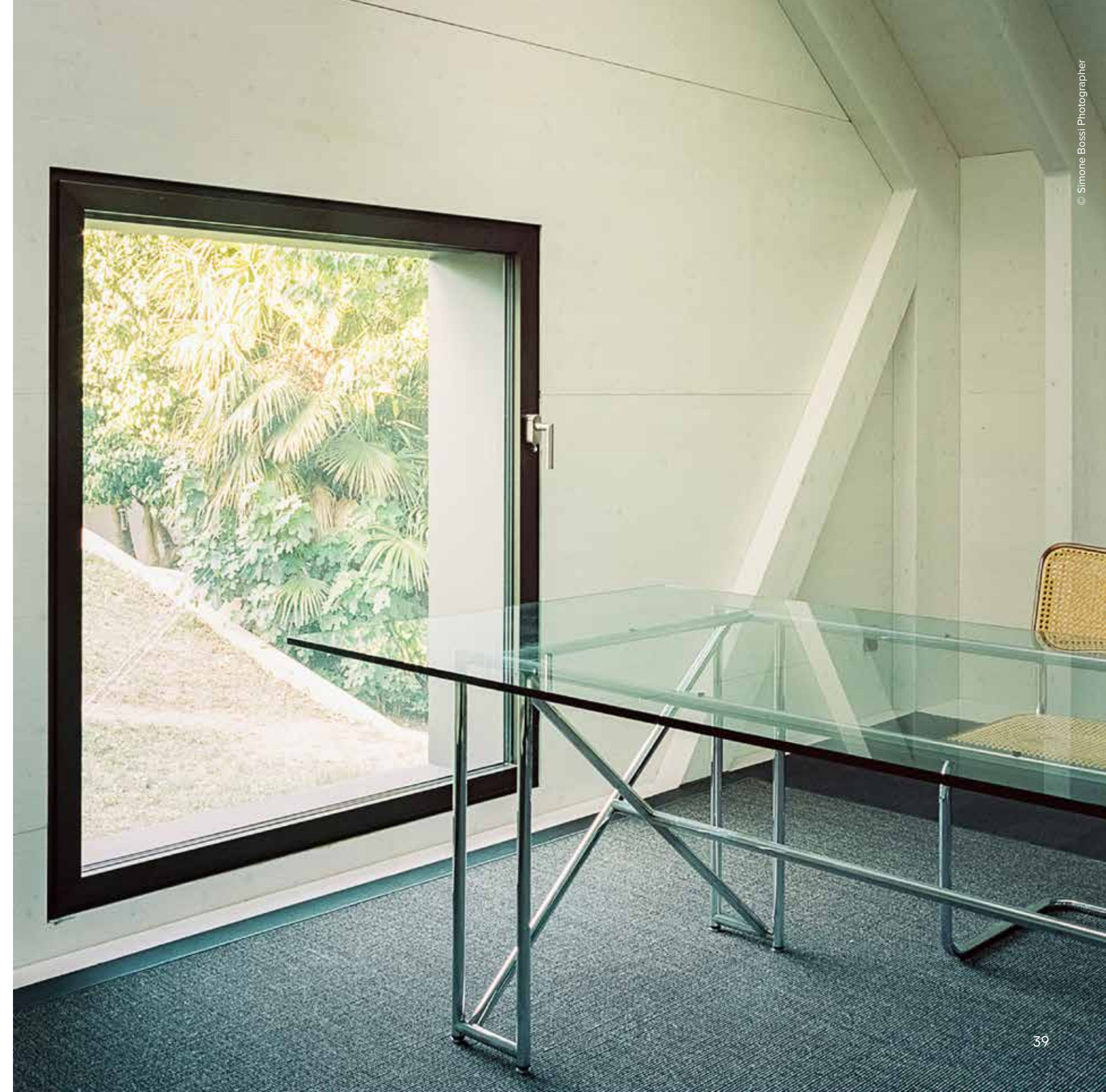
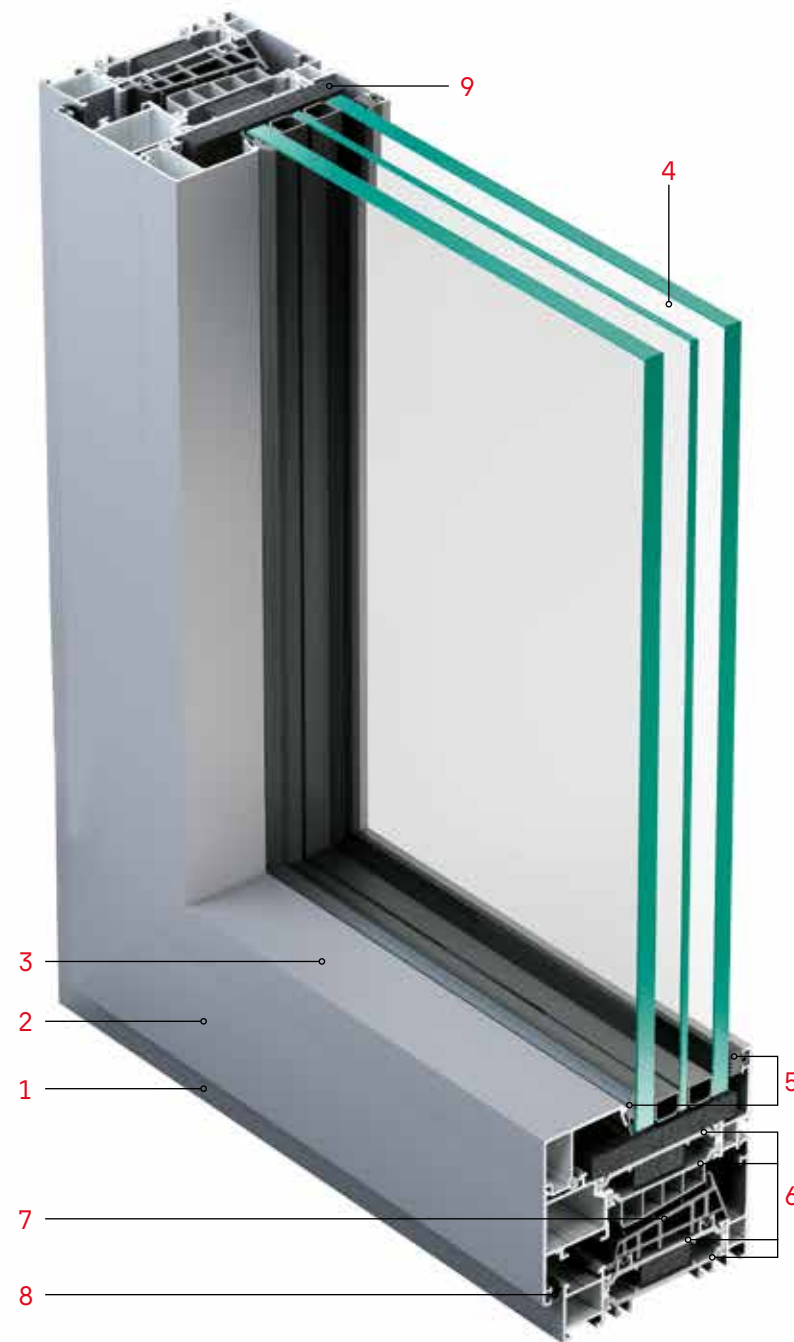



## Posa Clima: l'importanza della posa in opera

### Posa Clima: the importance of installation

L'innovativo sistema di posa firmato METRA assicura all'edificio un totale comfort termo-acustico e un importante risparmio energetico. Posa Clima è applicabile a tutti i prodotti METRA Building e offre altri vantaggi:

- è riciclabile
- è libero da stabilizzanti al piombo e altri metalli pesanti
- garantisce ottima resistenza agli agenti atmosferici e all'invecchiamento, anche con esposizione al sole, alla salsedine e ai più comuni agenti chimici
- è ignifugo e si autoestingue
- è facilmente verniciabile

*The innovative installation system signed METRA ensures the building a total thermal-acoustic comfort and a important energy saving. Posa Clima is applicable to all METRA Building products and offers other advantages:*

- *recyclable*
- *free of lead stabilisers and other heavy metals*
- *guarantees excellent resistance to atmospheric agents and ageing, even with exposure to the sun, salt and the most common chemical agents*
- *fireproof and self-extinguishing*
- *easy to paint*

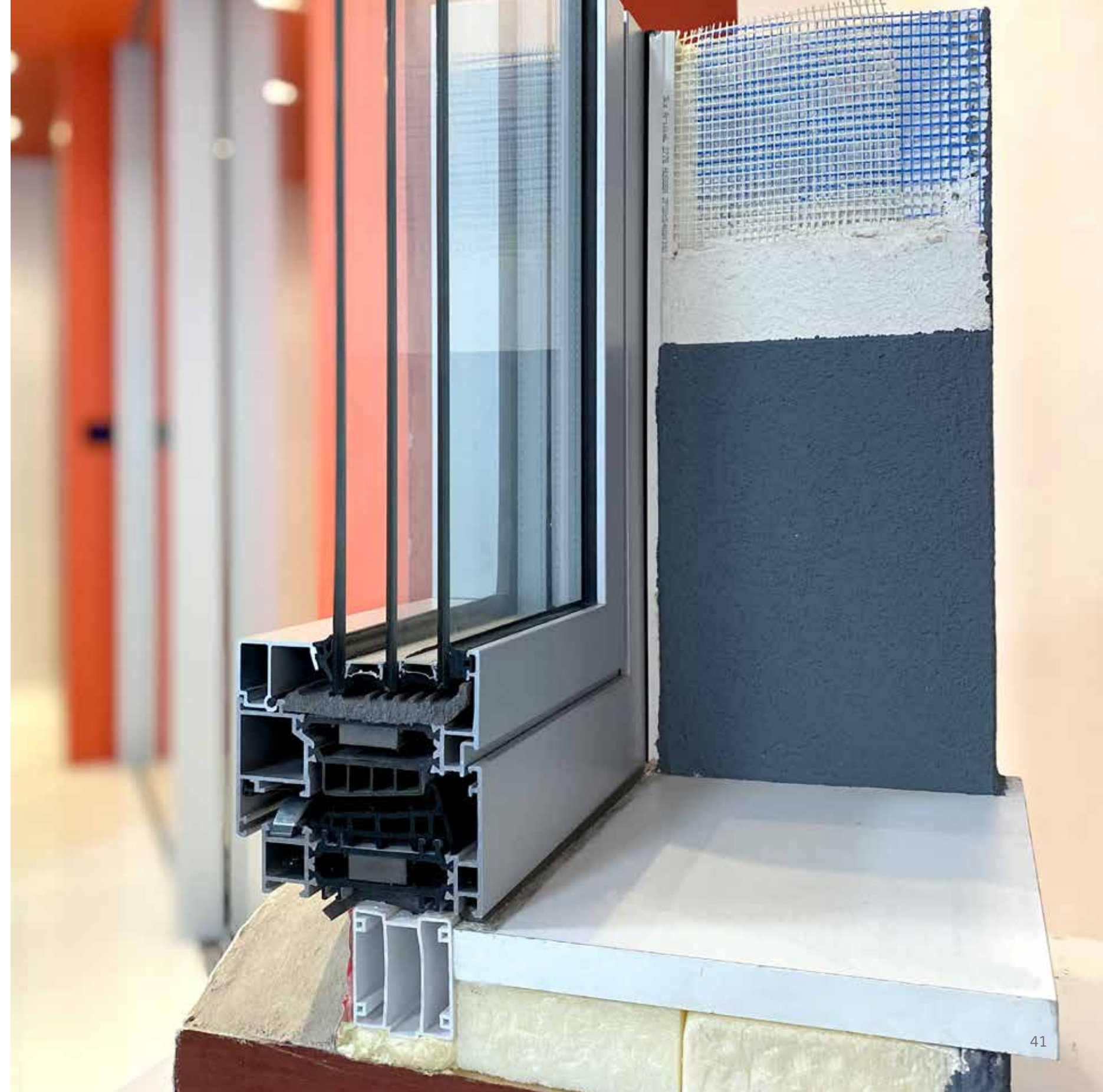



## Prestazioni Sistemi HES HES systems performances

### Tenuta all'acqua Water tightness EN 1027, EN 12208

Pressione d'aria applicata <i>Air pressure applied</i>	(0Pa)	(50Pa)	(100Pa)	(150Pa)	(200Pa)	(250Pa)	(300Pa)	(450Pa)	(600Pa)	(900Pa)
Km/h	0	32,2	45,53	55,77	64,39	72	78,87	96,59	111,54	136,6
<b>Fino a / Up to</b>	1A	2A	3A	4A	5A	6A	7A	8A	9A	E900

Linea Minimale / Minimal line: **Classe 9A** - Linea Origini / Origins line: **Classe 9A**

### Permeabilità all'aria Air permeability EN 1026 - EN 12207

Pressione d'aria applicata <i>Air pressure applied</i>	(150Pa)	(300Pa)	(450Pa)	(600Pa)
<b>Fino a / Up to</b>	1	2	3	4

Linea Minimale / Minimal line: **Classe 4** - Linea Origini / Origins line: **Classe 4**

### Resistenza al vento Resistance to wind load EN 12211 - EN 12210

Pressione d'aria applicata <i>Air pressure applied</i>	(400Pa)	(800Pa)	(1200Pa)	(1600Pa)	(2000Pa)	(>2000Pa)
Km/h	A ( $\leq 1/150$ )		B ( $\leq 1/200$ )		C ( $\leq 1/300$ )	
<b>Fino a / Up to</b>	1	2	3	4	5	Exxx

Linea Minimale / Minimal line: **Classe B4** - Linea Origini / Origins line: **Classe C5** [NC 90 STH HES: **Classe C4**]

### Potere fonoisolante Soundproofing power EN ISO 10140-3 - EN ISO 717-1

da **47 dB** a **48 dB** - from **47 dB** to **48 dB**

Linea Minimale / Minimal line: **47 dB**

Linea Origini / Origins line: NC 65 STH HES e NC 75 STH HES: **47 dB** - NC 90 STH HES: **48 dB**

### Resistenza all'effrazione Burglar resistance EN 1627 - EN 1630

<b>Fino a / Up to</b>	RC1	RC2	RC3
-----------------------	-----	-----	-----

Linea Origini / Origins line: **Classe RC3**

### Forze di azionamento Operating forces EN 13115

Classe raggiunta / Class achieved	Classe 0	Classe 1	Classe 2
	-	100 N	30 N

Linea Origini / Origins line: **Classe 1**

### Resistenza meccanica Mechanical resistance EN 12046 - EN 13115

Classe raggiunta / Class achieved	Classe 0	Classe 1	Classe 2	Classe 3	Classe 4

Linea Origini / Origins line: **Classe 4**

### Resistenza ai cicli di apertura e chiusura Resistance to repeated opening and closing cycles EN1191 - EN 12400

Classe raggiunta / N° di cicli <i>Class achieved / No.cycles</i>	0	1	2	3	4	5	6	7	8
	-	5000	10000	20000	50000	100000	200000	500000	1000000

Linea Origini / Origins line: **Classe 3/20.000**

### Resistenza all'urto Resistance to impact EN 1191 - EN 13049

Altezza di caduta / Drop height	200 mm	300 mm	450 mm	700 mm	950 mm
<b>Fino a / Up to</b>	1	2	3	4	5

Linea Origini / Origins line: **Classe 5**

### Trasmittanza termica Thermal transmittance

**Uw W/m² K** (finestra 1 anta 1230x1480 mm; vetro Ug 0,6 W/m² K, Psi 0,031 W/m K) / (window 1 casement 1230x1480 mm; glass Ug 0,6 W/m² K, Psi 0,031 W/m K)

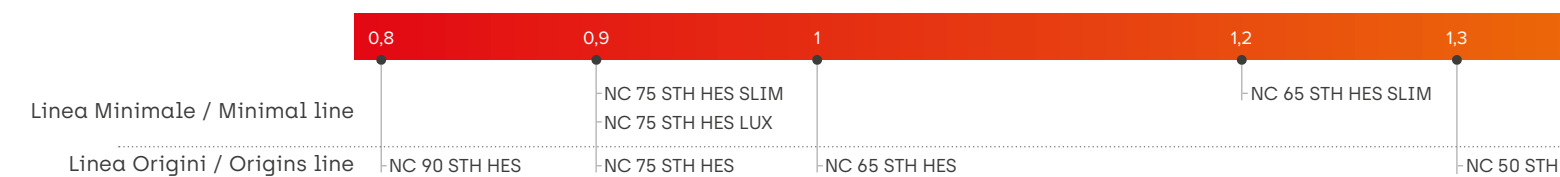







Via Stacca 1,  
25050 - Rodengo Saiano  
Brescia - Italy  
Tel. +39 030 68191  
Fax +39 030 6819990

[servizioclienti@metra.it](mailto:servizioclienti@metra.it)  
[www.metrabuilding.com](http://www.metrabuilding.com)

